

# HOME PUMP\*

Ambulatory Infusion System

Instructions For Use

## *HOME PUMP Eclipse\** Elastomeric Pump

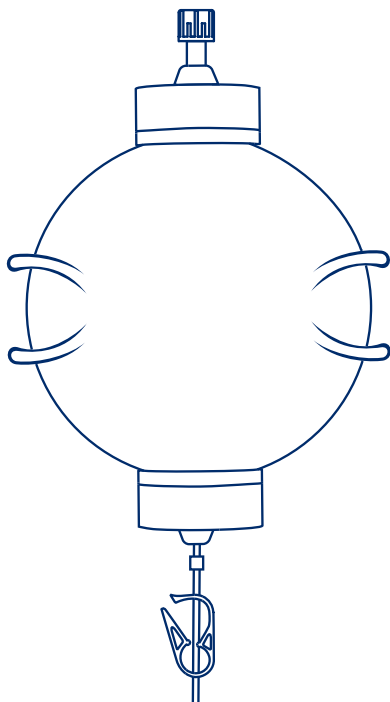

MANUFACTURED BY:

 **Kimberly-Clark**  
1400 Holcomb Bridge Road  
Roswell, GA 30076  
USA

**CE**  
0086

 Kimberly-Clark N.V.  
Da Vincilaan 1  
1935 Zaventem, Belgium



# HOME PUMP ECLIPSE\* Elastomeric Pump

## Instructions For Use

ⓔⓃ	Elastomeric Pump Instructions for Use	3
ⓔⓈ	Instrucciones de uso de la bomba elastomérica	9
ⓕⓇ	Mode d'emploi de la pompe élastomérique	15
ⓓⓔ	Bedienungsanleitung für die Elastomerpumpe	21
ⓈⓋ	Brukanvisning för elastomerisk pump	27
ⓔⓉ	Istruzioni per l'uso della pompa elastomerica	33
ⓃⓁ	Gebruiksaanwijzing voor elastomeerpomp	39
ⓕⓂ	Elastomeerisen pumpun käyttöohjeet	45
ⓔⓈ	Leiðbeiningar um notkun gúmmidælu	51
Ⓝⓓ	Elastomerisk pompe bruksanvisning	57
ⓔⓟ	Instruções de utilização da bomba de elastómero	63
ⓓⓐ	Elastomerisk pompe Brugsanvisning	69
ⓔⓁ	Οδηγίες χρήσης ελαστομερούς αντλίας	75
ⓐⓈ	Návod k použití elastomerové pumpy	83
ⓉⓇ	Elastomerik Pompa Kullanma Talimatı	89
ⓔⓁ	Instrukcja użytkowania pompy elastomerowej	95
Ⓡⓞ	Инструкция по применению эластомерного насоса	101
ⓙⓐ	エラストメトリックポンプの使用説明書	107
Ⓚⓞ	탄성체 펌프 사용 설명서	115
ⓐⓗ	合成橡胶药泵使用说明	123

Figure 1

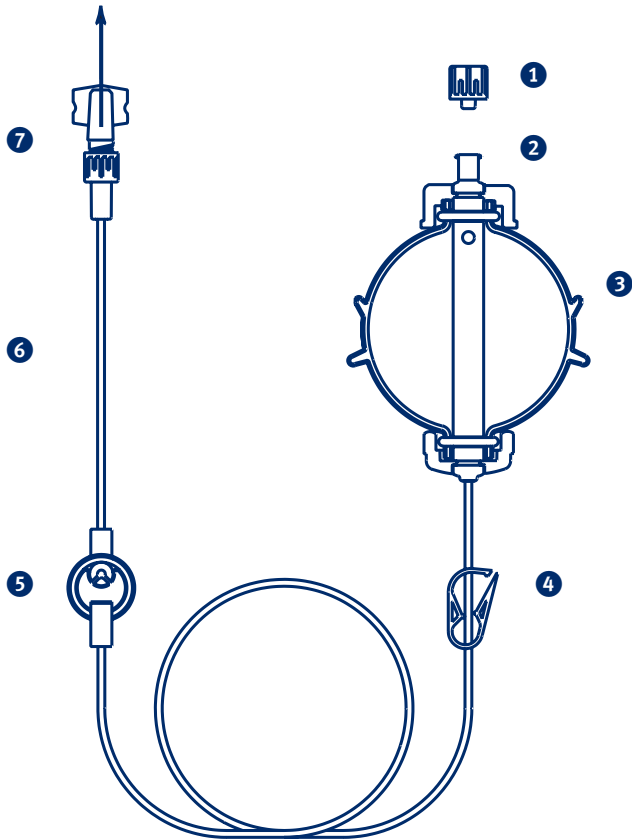

### DESCRIPTION OF DEVICE

Figure 1

- 1 Fill Port Cap
- 2 Fill Port
- 3 Elastomeric Pump
- 4 Clamp
- 5 Air Eliminating Filter
- 6 Flow Controller Tubing
- 7 Distal End Cap

**IMPORTANT INFORMATION**

Please read the entire document before operating the Homepump Eclipse\* device. Follow all instructions carefully to ensure the safety of patient and/or user.

**USER INFORMATION**



The Homepump Eclipse\* pump is designed for patients to use at home. Please see below for important patient information for home use:

- For 24-hour Product Support, call 800-444-2728 or +1.949-206-2700 (English only).
- Visit [www.ifla.com](http://www.ifla.com) or contact your sales representative for the latest product information and Technical Bulletins, including but not limited to:
  - Factors Affecting Flowrate Homepump\* Ambulatory Infusion System: Homepump Eclipse\*
  - Latex Sensitivity
  - Drug Stability Data
  - Patient Information Brochures

**⚠ WARNINGS**

- The Homepump Eclipse pump must be filled 4 hours prior to administration to infuse at the labeled flow rate.
  - If the pump is used immediately after filling, flow rate may increase by up to 50%.
- Medications or fluids must be administered per instructions provided by the drug manufacturer. Physician is responsible for prescribing drug based on each patient's clinical status (such as age, body weight, disease state of patient, concomitant medication, etc.).
- There is no alarm or alert when flow interruption occurs, therefore life-supporting medications whose usage may cause serious injury or death due to stoppage or under-delivery are not recommended for infusion with the device.
- There is no indicator of pump infusion status, therefore use caution where over-delivery of medications could result in serious injury or death.
- It is the responsibility of the healthcare provider to ensure patient is educated in the proper use of the system.

**⚠ CAUTIONS**

-  Do not use if package is open, damaged or a protector cap is missing.
-  The Homepump Eclipse\* pump is sterile, non-pyrogenic and single use only. Do not resterilize, refill or reuse. Reuse of the device could result in the following risks:
  - Improper functioning of the device (i.e. inaccurate flow rate)
  - Increased risk of infection
  - Occlusion of the device (i.e. impedes or stops infusion)
- Do not remove from package until ready to use.
-  Product uses Di (2-ethylhexyl) phthalate (DEHP) plasticized PVC:
  - DEHP is a commonly used plasticizer in medical devices. There is no conclusive scientific evidence to date that exposure to DEHP has a harmful effect on humans. However, the risk and benefit of using medical devices with DEHP for pregnant women, breastfeeding mothers, infants and children should be evaluated prior to use.
  - Certain solutions may be incompatible with the PVC material used in the administration set. Consult drug package insert and other available sources of information for a more thorough understanding of possible incompatibility problems.
- Do not fill less than minimum or exceed maximum fill volume of pump. (Table 1)
- Clamp is provided to stop the infusion. Do not remove or break clamp. Do not use clamp as an intermittent delivery device.
  - Roll tubing between fingers to promote flow if clamped for extended time.
- The labeled flow rate and fill volume for each pump are identified on the fill port.
- Avoid contact of cleaning agents (like soap and alcohol) with the filter because leakage may occur from the air eliminating vent.
- Do not tape over filter as this could block the air vent and impede the infusion.
- Do not immerse the pump in water. Take care to protect the pump during any activities which could cause the pump and filter to get wet, such as showering.
- Do not use a microwave, oven or water bath to warm the fluid.
- In the event of any leakage from the pump, or administration set, close tubing clamp. Replace pump if necessary.

- Do not discard the pump and contact I-Flow\* for product return instructions.
- **Flow rates may vary due to:**

#### Fill volume

- Filling the pump less than labeled (nominal) fill volume results in faster flow rate.
- Filling the pump greater than labeled (nominal) fill volume results in slower flow rate.

#### Viscosity and/or drug concentration

- The Homepump Eclipse\* pump labeled flow rates are based on the use of normal saline as the diluent.
- Addition of any drug or use of another diluent may change viscosity and result in increased or decreased flow rate. Use of 5% dextrose will result in 10% longer delivery time.

**Pump position** - Position the pump at approximately the same level as the catheter site.

- Positioning the pump above this level increases flow rate
- Positioning the pump below this level decreases flow rate.

#### Temperature

- Temperature will affect solution viscosity, resulting in shorter or longer delivery time.
- The Homepump Eclipse\* pump is designed to be used at room temperature (20°C/68°F).
- Flow rate will increase approximately 1.4% per 1° F/0.6° C increase in temperature and will decrease approximately 1.4% per 1° F/0.6° C decrease in temperature.
- Pump and tubing should be worn outside the clothing.
- If stored in the refrigerator or freezer, allow pump to reach room temperature before using. It may take several hours for a pump to reach room temperature, depending on fill volume. (Table 1)
- To ensure flow rate accuracy, do not place heat or cold therapy in close proximity to the flow controller tubing.

#### Storage

- Delivery time can increase significantly as a result of extended storage time.

#### External pressure

- External pressure such as squeezing, laying on the pump increases flow rate.

#### Catheter/Access Device

- When administering through a central or peripheral catheter, follow instructions provided by the catheter manufacturer. Peripherally inserted central catheter (PICC) lines smaller than 20 GA x 56 cm (or other restrictive devices) will decrease flow rate.

## INDICATIONS

Homepump Eclipse\* pump is indicated for continuous delivery of medications through intravenous routes.

## CONTRAINDICATIONS

The Homepump Eclipse\* pump is not intended for blood, blood products, lipids, fat emulsions, or Total Parenteral Nutrition (TPN).

## INSTRUCTIONS FOR USE

### Use Aseptic Technique

### FILLING THE HOMEPUMP ECLIPSE\* PUMP: (Figure 2)

**NOTE:** Follow standard protocols and applicable regulations for filling pump.

1. Close the clamp.
2. Remove the cap from the fill port and retain for later use.
3. The Homepump Eclipse\* pump can be filled with a syringe or similar device. Remove all air from the filling device and attach filled syringe to fill port. (Figure 2)
4. Invert pump as shown. Firmly grasp the syringe with both hands and push down on the plunger continuously until the volume is dispensed. Do not handle the pump while filling, as the syringe tip may break. Repeat as necessary.

**Figure 2**

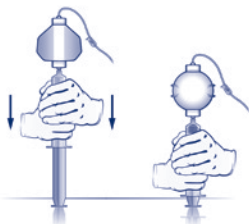

**CAUTION:** Do not fill less than minimum or exceed maximum fill volume (See Table 1 for model specific information on fill volumes).

5. Remove filling device from the fill port.
6. Securely replace fill port cap. Ensure that the distal end cap on the tubing is snug.
7. Label with appropriate pharmaceutical and patient information.

### **WARNING:**

The Homepump Eclipse pump must be filled 4 hours prior to administration to infuse at the labeled flow rate. If the pump is used immediately after filling, flow rate may increase by up to 50%.

## PRIMING THE ADMINISTRATION SET

### Use Aseptic Technique

**NOTE:** In order to avoid the risk of precipitation within the tubing, the Homepump Eclipse\* pump can be prefilled and primed with a small amount of diluent so that the medication is not in the pump tubing until the infusion is started. This technique can be used for any medication prone to precipitation.

**CAUTION:** It is important to completely prime the pump tubing. Failure to do so may prevent the pump from infusing.

1. Remove distal end cap.
2. Open clamp to start priming.
3. When all air has been removed from the entire tubing and fluid flow is observed at end of the distal luer, the administration set is primed.
4. Close clamp and replace distal end cap until ready for use.

## STARTING INFUSION

### Use Aseptic Technique

**NOTE:** Patient must be educated on proper use of product by healthcare provider.

1. Allow the Homepump Eclipse\* pump to reach room temperature before using. (Table 1)
2. Verify that the clamp on the tubing is closed.
3. Cleanse patient's catheter injection site/IV access device.
4. Attach the Homepump Eclipse\* pump tubing to the access device.
5. Begin infusion by opening the clamp; fluid delivery will start immediately.
  - **NOTE:** If tubing is kinked, roll kinked portion of the tubing between fingers to restore shape of tubing and promote fluid flow.

### END OF INFUSION:

- Infusion is complete when the elastomeric membrane is no longer expanded.
- Close clamp, disconnect and dispose of the Homepump Eclipse\* pump according to your institution's protocol.

**NOTE:** If the pump did not perform as expected do not discard pump. Contact I-Flow\* for product return instructions: [ifloproductcomplaint@kcc.com](mailto:ifloproductcomplaint@kcc.com) or +1.949.206.2700.

## TECHNICAL SPECIFICATIONS

**DELIVERY ACCURACY:** When filled to the labeled (nominal) volume, the Homepump Eclipse\* pump is  $\pm 15\%$  of the labeled (nominal) flow rate when infusion is started 4 hours after fill, delivering normal saline as the diluent at 20°C/68°F.

### TYPICAL FLOW CURVE

Below is a graph of the typical flow profile of the Homepump Eclipse\* elastomeric pump. The flow rate may be higher or lower than  $\pm 15\%$  at the start and end of infusion.

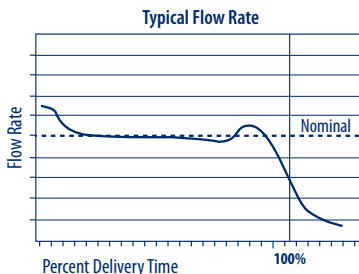

### NOTES:

- *Latex is not in fluid pathway or in contact with human. Refer to Latex Sensitivity - Homepump\* Technical Bulletin available at [www.iflo.com](http://www.iflo.com).*
- *Length of tubing is approximately 96  $\pm$  20 cm (38  $\pm$  8 inches)*

### STORAGE CONDITIONS

Store under general warehouse conditions. Protect from light sources and heat. Keep dry.

**TABLE 1: Delivery Time Information****⚠ CAUTION:**

- Filling the pump less than the labeled volume results in faster flow rate.
- Filling the pump greater than the labeled volume results in slower flow rate.

Models	E050500	E100500	E101000	E102000	E251750	E252500	E401000	E402000	E502500
	SE050500	SE100500	SE101000	SE102000					
Labeled Fill Volume (ml)	50	100	100	100	250	250	400	400	500
Labeled Flow Rate (ml/hr)	50	50	100	200	175	250	100	200	250
Minimum Fill Volume (ml)	28	60	65	60	200	250	200	200	300
Maximum Fill Volume (ml)	65	125	125	125	335	335	500	550	550
Retained Volume (ml)	≤3	≤3	≤3	≤3	≤8	≤8	≤10	≤10	≤10
<b>Time to Reach Room Temperature</b>									
Hours from refrigerator	7	8	8	8	12	12	15	15	18
Hours from freezer	12	16	16	16	25	25	29	29	30
<b>Approximate Delivery Time</b>					<b>Fill Volume (ml)</b>				
00:15 h				60					
00:30 h	28		65	100					
00:40 h				125					
00:45 h								200	
01:00 h	50	60	100		200	250		250	300
01:15 h	65		125						
01:20 h					250	335		300	
01:30 h		80							400
01:35 h							200		
01:40 h								350	
01:45 h					300				
02:00 h		100			335		250	400	500
02:15 h								450	550
02:30 h		120							
02:35 h							300		
02:40 h		125						500	
03:00 h							350		
04:00 h							400		
04:45 h							450		
05:15 h							500		



**Rx only** = CAUTION: Federal (U.S.A.) law restricts this device to sale by or on the order of a physician.

U.S. Patents and Foreign Patents Pending.

\*Registered Trademark or Trademark of Kimberly-Clark Worldwide, Inc. or its affiliates. © 2010 KCWW. All Rights Reserved.

For more information, please call  
**+1.949.206.2700 • 1.800.448.3569** (English  
only) or visit [www.iflo.com](http://www.iflo.com) for the latest product  
information and Technical Bulletins.

---

To order additional Instructions for Use or Patient  
Guidelines please email or call:  
[internationalorders@iflo.com](mailto:internationalorders@iflo.com) or +1.949.206.2688